



SERIES VRG130



Mtrl.nr. 9814 02 69 • Ritn.nr. 7045 utg. E • Rev. 1505



Series VRG131
Series VRG132
Series VRG133
Series VRG138
Series VRG139

PED 2014/68/EU, article 4.3

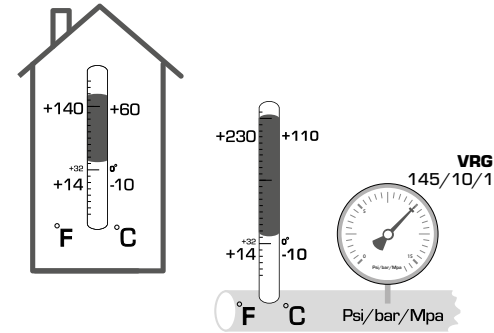

1

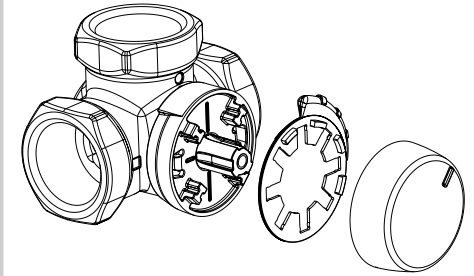

i

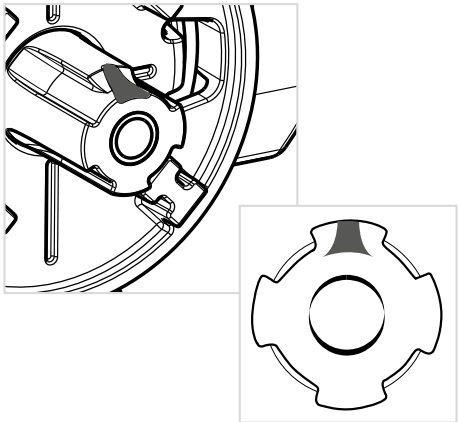

i

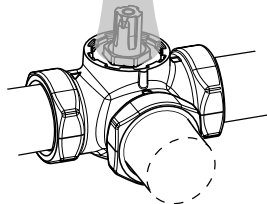
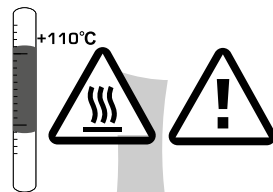
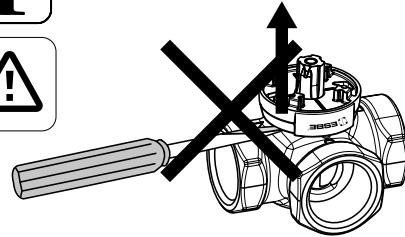

2

a

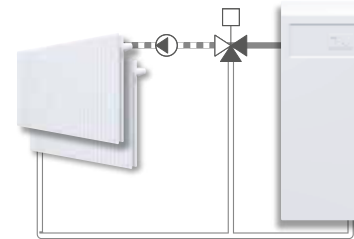
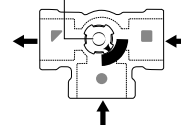
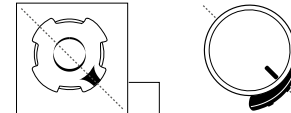

b

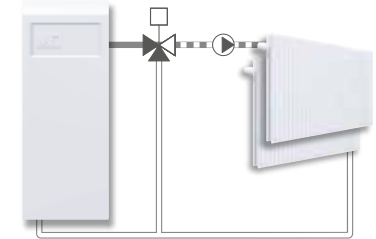
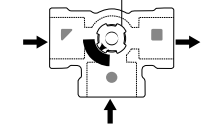

Piping Schematics are General Representations

3

a

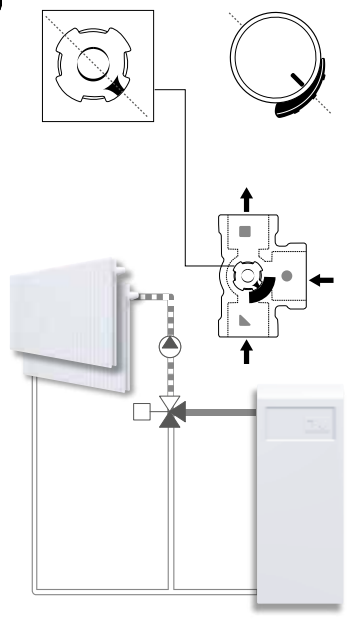

b

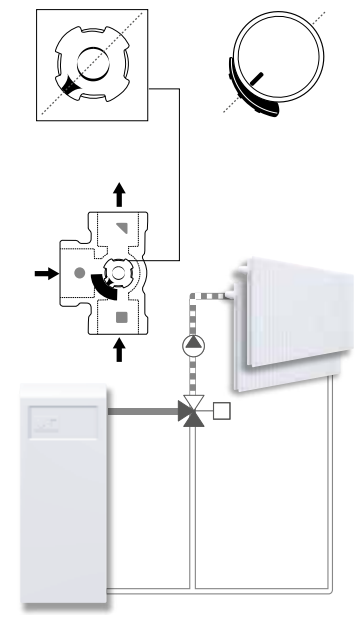

4

a

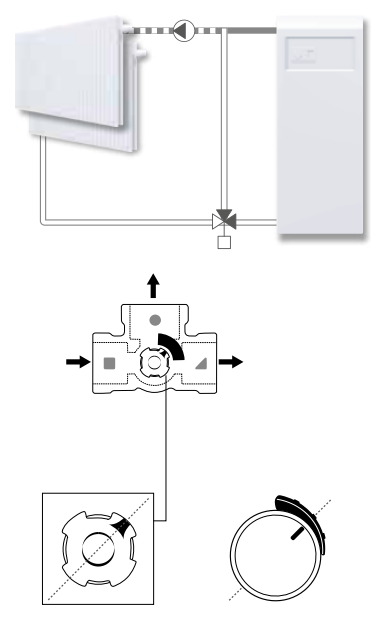

b

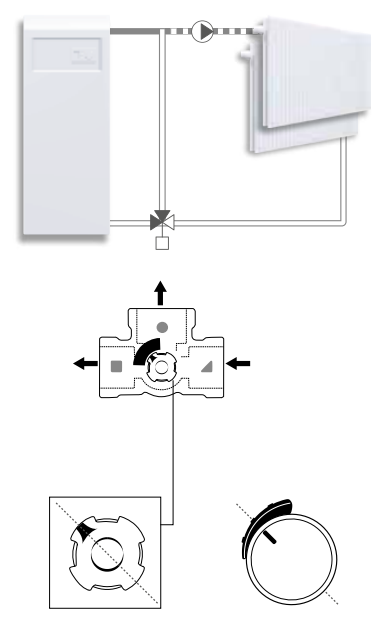

i



<http://www.esbe.eu/global/en/products/rotary-valves>